

# ITS RTM15 Process Temperature Sensors



ITS is one of the leading manufacturers of thermocouples, RTDs, PT100s and thermowells in Ireland. ITS produces a variety of temperature sensors and assemblies in both standard and custom designs, which can be found on equipment and in process applications in the chemical, petrochemical, power generation, food & beverage, dairy, plastics, heat-treating, oil & gas, pharmaceutical, aerospace, biomass, metal processing, rubber, mining, HVAC, water & wastewater, incineration, and many other industries.

- RTDs and thermocouples available to meet any process requirement
- Integrated temperature assembly with transmitters available
- Temperature range of  $-196$  to  $650$  °C for RTD,  $-196$  to  $1450$  °C for thermocouple
- Industry-standard sensor types, including RTD and thermocouple varieties
- Variety of enclosure and connection head options
- Calibration services available

**Overview**

- Room Sensor with housing
- Wall Mount
- PT100, PT1000, 4 ... 20 mA or HART output
- Class configurable

**Technical data**
**Performance characteristics**

Pt100 accuracy class (EN 60751)	A ( $\pm 0.15 \text{ }^\circ\text{C}$ at $0 \text{ }^\circ\text{C}$ ) $\pm (0.15 + 0.002 \times t)^\circ\text{C}$ 1/3 B ( $\pm 0.1 \text{ }^\circ\text{C}$ at $0 \text{ }^\circ\text{C}$ ) $\pm 1/3 \times (0.3 + 0.005 \times t)^\circ\text{C}$
---------------------------------	---

Pt1000 accuracy class (EN60751)	A ( $\pm 0.15 \text{ }^\circ\text{C}$ at $0 \text{ }^\circ\text{C}$ ) $\pm (0.15 + 0.002 \times t)^\circ\text{C}$ 1/3 B ( $\pm 0.1 \text{ }^\circ\text{C}$ at $0 \text{ }^\circ\text{C}$ ) $\pm 1/3 \times (0.3 + 0.005 \times t)^\circ\text{C}$
---------------------------------	---

Thermal response time T50	$\leq 3 \text{ s}$
---------------------------	--------------------

Process temperature	$-40 \dots 85 \text{ }^\circ\text{C}$
---------------------	---------------------------------------

**Process connection**

Enclosure	Wall Mount ABS Enclosure
-----------	--------------------------

**Operating Temperature**

Standard	$85 \text{ }^\circ\text{C}$
----------	-----------------------------

**Ambient conditions**

Temperature range	$-40 \dots 85 \text{ }^\circ\text{C}$ , with Pt100
Storage temperature range	$-40 \dots 85 \text{ }^\circ\text{C}$ , with transmitter
Degree of protection (EN60529)	IP20
Humidity	$\leq 100 \text{ \% RH}$ condensing

**Output signal**

Without transmitter	1 x Pt100, 3 or 4-wire
	2x Pt100, 3-wire
	1 x Pt1000, 3-wire
	2 x PT1000 3-wire
With transmitter	4 ... 20 mA, 2-wire
	4 ... 20 mA, 2-wire + HART®

**Housing**

Style	ABS Vented
Overall size	84 x 82 x 55mm
Material	Plastic ABS

**Electrical connection**

Back Entry	Punch out hole
------------	----------------

**ATEX**

II 1 GD  
 Ex ia IIC T4 Ga  
 Ex ia IIC T135°C Da  
 Ta =  $-40 \text{ }^\circ\text{C}$  to  $+80 \text{ }^\circ\text{C}$

**Transmitter**
**5333A**

Input	RTD or Ohm input
Input Accuracy	$\leq \pm 0.1\%$ of span
Min. measuring span	25 °C
Output	4 ... 20 mA , 20 ... 4 mA 2 wire
Output Accuracy	$\leq \pm 0.1\%$ , measuring span $\leq \pm 0.016$ mA
Power supply	8 ... 35 V DC
Programmability	With Loop Link interface 5909
Please note	For further information please see data sheet 5333A

**5333D** 

Input	RTD Ohm input
Input Accuracy	$\leq \pm 0.1\%$ of span
Min. measuring span	25 °C
Output	4 ... 20 mA , 2-wire 20 ... 4 mA , programmable
Output Accuracy	$\leq \pm 0.1\%$ , measuring span $\leq \pm 0.016$ mA
Power supply	8 ... 35 V DC
Programmability	With Loop Link interface 5909
Please note	For further information please see data sheet for 5333D

**5331A**

Input	RTD, TC, Ohm, or mV input
Input Accuracy	Better than 0.05% of selected range
Min. measuring span	25 °C
Output	4 ... 20 mA , 20 ... 4 mA , programmable
Output Accuracy	$\leq \pm 0.025\%$ , measuring span $\leq \pm 0.004$ mA
Power supply	8 ... 35 V DC
Programmability	With Loop Link 5909
Please note	For further information please see data sheet for 5331A

**5331D** 

Input	RTD, TC, Ohm, or mV input
Input Accuracy	Better than 0.05% of selected range
Min. measuring span	25 °C
Output	4 ... 20 mA , 2-wire 20 ... 4 mA , programmable
Output Accuracy	$\leq \pm 0.025\%$ , measuring span $\leq \pm 0.004$ mA
Power supply	8 ... 35 V DC
Programmability	With Loop Link 5909
Please note	For further information please see data sheet for 5331D

**5337D** 

Input	RTD, TC, Ohm, and bipolar mV input
Input Accuracy	Better than 0.05% of selected range
Min. measuring span	10 °C
Output	4 ... 20 mA , 2-wire + HART® 20 ... 4 mA , programmable
Output Accuracy	$\leq \pm 0.025\%$ , measuring span $\leq \pm 0.004$ mA
Power supply	8 ... 30 mA
Programmability	With Loop Link 5909 With HART®modem
Please note	For further information please see data sheet for 5337D

**7501** 

Input	RTD, TC, Ohm, and bipolar mV input
Input Accuracy	Better than 0.05% of selected range
Min. measuring span	10 °C
Output	4 ... 20 mA , 2-wire 20 ... 4 mA , programmable
Output Accuracy	$\leq \pm 0.025\%$ , measuring span $\leq \pm 0.004$ mA
Power supply	10 (12 - with backlight)...30 VDC
Programmability	With Local operator interface With HART® modem
Please note	For further information please see data sheet for 7501

**Factory settings**

Output range	0 ... 150 °C
Input	PT100 3-wire
Output at sensor fault	Upscale



**Dimensional drawings (mm)**

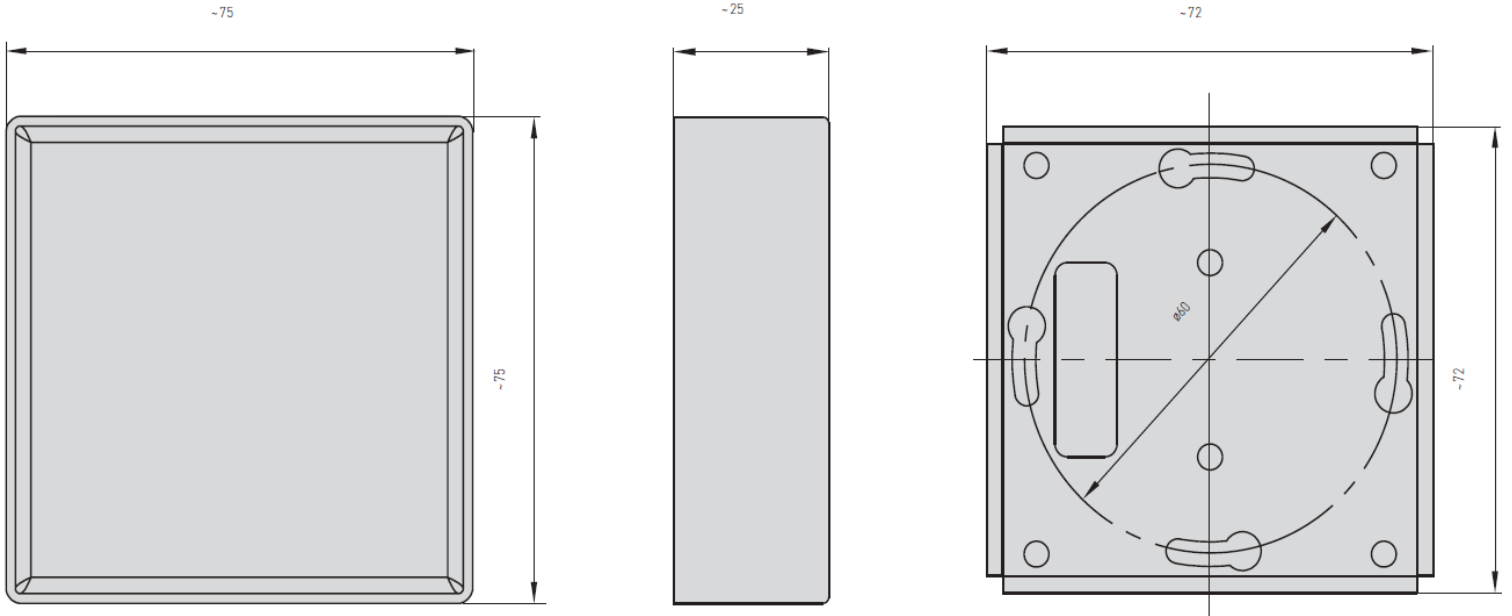

**Terminal Block Wiring**

**2 Wire**

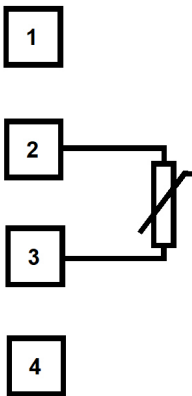

**3 Wire**

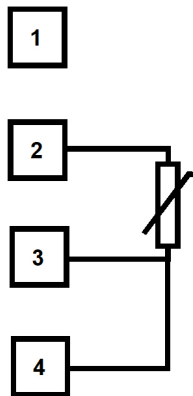

**4 Wire**

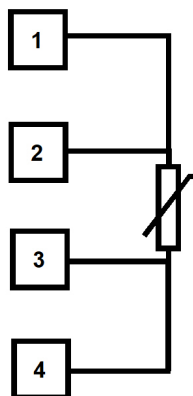

**2 x 2/3 Wire**

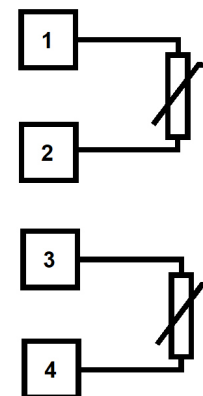

**Transmitter Wiring**

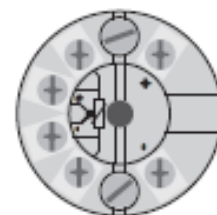
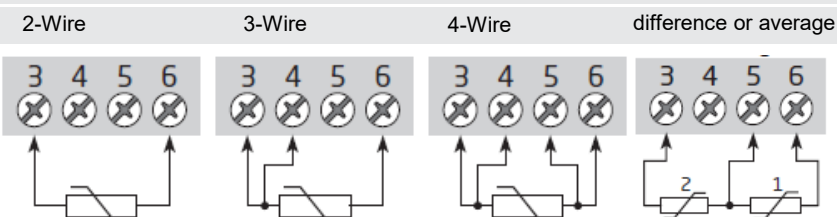



**Configuration & Order Information**

<b>Product</b>	RTIRMX	85C	- ##	- ###	- ABSV	- #####	-
<b>Operating Temperature °C</b>							
Standard (STD) -70C+250C		85C					
<b>Number of Wires</b>							
3 wire			3W				
4 wire			4W				
<b>Element/Tolerance</b>							
Single Element Class A (±0.15°C @ 0°C)				SA			
Dual Element Class A (±0.15°C @ 0°C)				DA			
Single Element Class 1/3rd Din (±0.1°C @ 0°C)				S13			
Dual Element Class 1/3rd Din (±0.1°C @ 0°C)				D13			
<b>Termination Head</b>							
ABS Plastic Enclosure					ABSV		
<b>Termination</b>							
Flying Leads						FL	
Termination Block						TB	
2-wire transmitter 4/20ma Output							5333A
2-wire transmitter 4/20ma Output							5331A
Ex Rated 2-wire transmitter P 4/20ma Output							5333D
Ex Rated 2-wire transmitter 4/20ma Output							5331D
Ex Rated 2-wire transmitter 4/20ma Output HART 5 or HART 7							5337D

If 4...20mA selected specify required programmed range ex. /0+100C

Ü[ [ { Á^{ ] ^|æ | ^Á^ } • [ |

## RTD Accuracy

ACTUAL	RTD ACCURACY +/- °C PT100 Ω ALPHA 0.003850 to DIN 43760 IEC751 DIN EN 60 751			
	B GRADE	A GRADE	BAND 3 (1/3 DIN)	BAND 5 (1/10 DIN)
-200 °C	1.30 °C	0.55 °C	0.39 °C	0.38 °C
-150 °C	1.05 °C	0.45 °C	0.23 °C	0.21 °C
-100 °C	0.80 °C	0.35 °C	0.15 °C	0.12 °C
-90 °C	0.75 °C	0.33 °C	0.14 °C	0.10 °C
-80 °C	0.70 °C	0.31 °C	0.13 °C	0.09 °C
-70 °C	0.65 °C	0.29 °C	0.12 °C	0.08 °C
-60 °C	0.60 °C	0.27 °C	0.11 °C	0.07 °C
-50 °C	0.55 °C	0.25 °C	0.10 °C	0.06 °C
-40 °C	0.50 °C	0.23 °C	0.10 °C	0.06 °C
-30 °C	0.45 °C	0.21 °C	0.09 °C	0.05 °C
-20 °C	0.40 °C	0.19 °C	0.09 °C	0.04 °C
-10 °C	0.37 °C	0.17 °C	0.08 °C	0.03 °C
0 °C	0.30 °C	0.15 °C	0.08 °C	0.03 °C
10 °C	0.35 °C	0.17 °C	0.09 °C	0.04 °C
20 °C	0.40 °C	0.19 °C	0.10 °C	0.04 °C
30 °C	0.45 °C	0.21 °C	0.11 °C	0.05 °C
40 °C	0.50 °C	0.23 °C	0.12 °C	0.06 °C
50 °C	0.55 °C	0.25 °C	0.13 °C	0.07 °C
60 °C	0.60 °C	0.27 °C	0.14 °C	0.08 °C
70 °C	0.65 °C	0.29 °C	0.16 °C	0.09 °C
80 °C	0.70 °C	0.31 °C	0.17 °C	0.10 °C
90 °C	0.75 °C	0.33 °C	0.18 °C	0.11 °C
100 °C	0.80 °C	0.35 °C	0.19 °C	0.12 °C
110 °C	0.85 °C	0.37 °C	0.20 °C	0.13 °C
120 °C	0.90 °C	0.39 °C	0.21 °C	0.14 °C
130 °C	0.95 °C	0.41 °C	0.22 °C	0.15 °C
140 °C	1.00 °C	0.43 °C	0.24 °C	0.15 °C
150 °C	1.05 °C	0.45 °C	0.25 °C	0.16 °C
160 °C	1.10 °C	0.47 °C	0.26 °C	0.17 °C
170 °C	1.15 °C	0.49 °C	0.27 °C	0.18 °C
180 °C	1.20 °C	0.51 °C	0.29 °C	0.19 °C
190 °C	1.25 °C	0.53 °C	0.30 °C	0.21 °C
200 °C	1.30 °C	0.55 °C	0.31 °C	0.22 °C

Saved as 1393

# Temperature Conversion Table

# RT Table

## Platinum Resistance (-200°C to 239°C)

Temperature Coefficient - 0.00385 Ohms/Ohm/°C

°C	Ohms	°C	Ohms	°C	Ohms	°C	Ohms	°C	Ohms	°C	Ohms	°C	Ohms
-200	18.49	-137	45.11	-74	70.73	-11	95.69	51	119.78	114	143.80	177	167.35
-199	18.93	-136	45.52	-73	71.13			52	120.16	115	144.17	178	167.72
-198	19.36	-135	45.94	-72	71.53	-10	96.09	53	120.55	116	144.55	179	168.09
-197	19.79	-134	46.35	-71	71.93	-9	96.48	54	120.93	117	144.93		
-196	20.22	-133	46.76			-8	96.87	55	121.32	118	145.31	180	168.46
-195	20.65	-132	47.18	-70	72.33	-7	97.26	56	121.70	119	145.68	181	168.83
-194	21.08	-131	47.59	-69	72.73	-6	97.65	57	122.09			182	169.20
-193	21.51			-68	73.13	-5	98.04	58	122.47	120	146.06	183	169.57
-192	21.94	-130	48.00	-67	73.53	-4	98.44	59	122.86	121	146.44	184	169.94
-191	22.37	-129	48.41	-66	73.93	-3	98.83			122	146.81	185	170.31
		-128	48.82	-65	74.33	-2	99.22	60	123.24	123	147.19	186	170.68
-190	22.80	-127	49.23	-64	74.73	-1	99.61	61	123.62	124	147.57	187	171.05
-189	23.23	-126	49.64	-63	75.13			62	124.01	125	147.94	188	171.42
-188	23.66	-125	50.06	-62	75.53	0	100.00	63	124.39	126	148.32	189	171.79
-187	24.09	-124	50.47	-61	75.93	1	100.39	64	124.77	127	148.70		
-186	24.52	-123	50.88			2	100.78	65	125.16	128	149.07	190	172.16
-185	24.94	-122	51.29	-60	76.33	3	101.17	66	125.54	129	149.45	191	172.53
-184	25.37	-121	51.70	-59	76.73	4	101.56	67	125.92			192	172.90
-183	25.80			-58	77.13	5	101.95	68	126.31	130	149.82	193	173.26
-182	26.23	-120	52.11	-57	77.52	6	102.34	69	126.69	131	150.20	194	173.63
-181	26.65	-119	52.52	-56	77.92	7	102.73			132	150.57	195	174.00
		-118	52.92	-55	78.32	8	103.12	70	127.07	133	150.95	196	174.37
-180	27.08	-117	53.33	-54	78.72	9	103.51	71	127.45	134	151.33	197	174.74
-179	27.50	-116	53.74	-53	79.11			72	127.84	135	151.70	198	175.10
-178	27.93	-115	54.15	-52	79.51	10	103.90	73	128.22	136	152.08	199	175.47
-177	28.35	-114	54.56	-51	79.91	11	104.29	74	128.60	137	152.45		
-176	28.78	-113	54.97			12	104.68	75	128.98	138	152.83	200	175.84
-175	29.20	-112	55.38	-50	80.31	13	105.07	76	129.37	139	153.20	201	176.21
-174	29.63	-111	55.78	-49	80.70	14	105.46	77	129.75			202	176.57
-173	30.05			-48	81.10	15	105.85	78	130.13	140	153.58	203	176.94
-172	30.47	-110	56.19	-47	81.50	16	106.24	79	130.51	141	153.95	204	177.31
-171	30.90	-109	56.60	-46	81.89	17	106.63			142	154.32	205	177.68
		-108	57.00	-45	82.29	18	107.02	80	130.89	143	154.70	206	178.04
-170	31.32	-107	57.41	-44	82.69	19	107.40	81	131.27	144	155.07	207	178.41
-169	31.74	-106	57.82	-43	83.08			82	131.66	145	155.45	208	178.78
-168	32.16	-105	58.22	-42	83.48	20	107.79	83	132.04	146	155.82	209	179.14
-167	32.59	-104	58.63	-41	83.88	21	108.18	84	132.42	147	156.19		
-166	33.01	-103	59.04			22	108.57	85	132.80	148	156.57	210	179.51
-165	33.43	-102	59.44	-40	84.27	23	108.96	86	133.18	149	156.94	211	179.88
-164	33.85	-101	59.85	-39	84.67	24	109.35	87	133.56			212	180.24
-163	34.27			-38	85.06	25	109.73	88	133.94	150	157.31	213	180.61
-162	34.69	-100	60.25	-37	85.46	26	110.12	89	134.32	151	157.69	214	180.97
-161	35.11	-99	60.66	-36	85.85	27	110.51			152	158.06	215	181.34
		-98	61.06	-35	86.25	28	110.90	90	134.70	153	158.43	216	181.71
-160	35.53	-97	61.47	-34	86.64	29	111.28	91	135.08	154	158.81	217	182.07
-159	35.95	-96	61.87	-33	87.04			92	135.46	155	159.18	218	182.44
-158	36.37	-95	62.28	-32	87.43	30	111.67	93	135.84	156	159.55	219	182.80
-157	36.79	-94	62.68	-31	87.83	31	112.06	94	136.22	157	159.93		
-156	37.21	-93	63.09			32	112.45	95	136.60	158	160.30	220	183.17
-155	37.63	-92	63.49	-30	88.22	33	112.83	96	136.98	159	160.67	221	183.53
-154	38.04	-91	63.90	-29	88.62	34	113.22	97	137.36			222	183.90
-153	38.46			-28	89.01	35	113.61	98	137.74	160	161.04	223	184.26
-152	38.88	90	64.30	-27	89.40	36	113.99	99	138.12	161	161.42	224	184.63
-151	39.30	-89	64.70	-26	89.80	37	114.38			162	161.79	225	184.99
		-88	65.11	-25	90.19	38	114.77	100	138.50	163	162.16	226	185.36
-150	39.71	-87	65.51	-24	90.59	39	115.15	101	138.88	164	162.53	227	185.72
-149	40.13	-86	65.91	-23	90.98			102	139.26	165	162.90	228	186.09
-148	40.55	-85	66.31	-22	91.37	40	115.54	103	139.64	166	163.27	229	186.45
-147	40.96	-84	66.72	-21	91.77	41	115.93	104	140.02	167	163.65		
-146	41.38	-83	67.12			42	116.31	105	140.39	168	164.02	230	186.82
-145	41.79	-82	67.52	-20	92.16	43	116.70	106	140.77	169	164.39	231	187.18
-144	42.21	-81	67.92	-19	92.55	44	117.08	107	141.15			232	187.54
-143	42.63			-18	92.95	45	117.47	108	141.53	170	164.76	233	187.91
-142	43.04	-80	68.33	-17	93.34	46	117.85	109	141.91	171	165.13	234	188.27
-141	43.45	-79	68.73	-16	93.73	47	118.24			172	165.50	235	188.63
		-78	69.13	-15	94.12	48	118.62	110	142.29	173	165.87	236	189.00
-140	43.87	-77	69.53	-14	94.52	49	119.01	111	142.66	174	166.24	237	189.36
-139	44.28	-76	69.93	-13	94.91			112	143.04	175	166.61	238	189.72
-138	44.70	-75	70.33	-12	95.30	50	119.40	113	143.42	176	166.98	239	190.09



## Platinum Resistance (240°C to 629°C)

Temperature Coefficient - 0.00385 Ohms/Ohm/°C

°C	Ohms	°C	Ohms	°C	Ohms	°C	Ohms	°C	Ohms	°C	Ohms	°C	Ohms
240	190.45	301	212.37	362	233.87	423	254.93	484	275.56	545	295.75	606	315.52
241	190.81	302	212.73	363	234.22	424	255.27	485	275.89	546	296.08	607	315.84
242	191.18	303	213.09	364	234.56	425	255.61	486	276.23	547	296.41	608	316.16
243	191.54	304	213.44	365	234.91	426	255.95	487	276.56	548	296.74	609	316.48
244	191.90	305	213.80	366	235.26	427	256.29	488	276.89	549	297.06		
245	192.26	306	214.15	367	235.61	428	256.63	489	277.23			610	316.80
246	192.63	307	214.51	368	235.96	429	258.98			550	297.39	611	317.12
247	192.99	308	214.86	369	236.31			490	277.56	551	297.72	612	317.44
248	193.35	309	215.22			430	257.32	491	277.90	552	298.04	613	317.76
249	193.71			370	236.65	431	257.66	492	278.23	553	298.37	614	318.08
		310	215.57	371	237.00	432	258.00	493	278.56	554	298.70	615	318.40
250	194.07	311	215.93	372	237.35	433	258.34	494	278.90	555	299.02	616	318.72
251	194.44	312	216.28	373	237.70	434	258.68	495	279.23	556	299.35	617	319.04
252	194.80	313	216.64	374	238.04	435	259.02	496	279.56	557	299.68	618	319.36
253	195.16	314	216.99	375	238.39	436	259.36	497	279.90	558	300.00	619	319.68
254	195.52	315	217.35	376	238.74	437	259.70	498	280.23	559	300.33		
255	195.88	316	217.70	377	239.09	438	260.04	499	280.56			620	319.99
256	196.24	317	218.05	378	239.43	439	260.38			560	300.65	621	320.31
257	196.60	318	218.41	379	239.78			500	280.90	561	300.98	622	320.63
258	196.96	319	218.76			440	260.72	501	281.23	562	301.31	623	320.95
259	197.33			380	240.13	441	261.06	502	281.56	563	301.63	624	321.27
		320	219.12	381	240.47	442	261.40	503	281.89	564	301.96	625	321.59
260	197.69	321	219.47	382	240.82	443	261.74	504	282.23	565	302.28	626	321.91
261	198.05	322	219.82	383	241.17	444	262.08	505	282.56	566	302.61	627	322.22
262	198.41	323	220.18	384	241.51	445	262.42	506	282.89	567	302.93	628	322.54
263	198.77	324	220.53	385	241.86	446	262.76	507	283.22	568	303.26	629	322.86
264	199.13	325	220.88	386	242.20	447	263.10	508	283.55	569	303.58		
265	199.49	326	221.24	387	242.55	448	263.43	509	283.89				
266	199.85	327	221.59	388	242.90	449	236.77			570	303.91		
267	200.21	328	221.94	389	243.24			510	284.22	571	304.23		
268	200.57	329	222.29			450	264.11	511	284.55	572	304.56		
269	200.93			390	243.59	451	264.45	512	284.88	573	304.88		
		330	222.65	391	243.93	452	264.79	513	285.21	574	305.20		
270	201.29	331	223.00	392	244.28	453	265.13	514	285.54	575	305.53		
271	201.65	332	223.35	393	244.62	454	265.46	515	285.87	576	305.85		
272	202.01	333	223.70	394	244.97	455	265.80	516	286.21	577	306.18		
273	202.36	334	224.06	395	245.31	456	266.14	517	286.54	578	306.50		
274	202.72	335	224.41	396	245.66	457	266.48	518	286.87	579	306.82		
275	203.08	336	224.76	397	246.00	458	266.82	519	287.20				
276	203.44	337	225.11	398	246.35	459	267.15			580	307.15		
277	203.80	338	225.46	399	246.69			520	287.53	581	307.47		
278	204.16	339	225.81			460	267.49	521	287.86	582	307.79		
279	204.52			400	247.04	461	267.83	522	288.19	583	308.12		
		340	226.17	401	247.38	462	268.17	523	288.52	584	308.44		
280	204.88	341	226.52	402	247.72	463	268.50	524	288.85	585	308.76		
281	205.23	342	226.87	403	248.07	464	268.84	525	289.18	586	309.09		
282	205.59	343	227.22	404	248.41	465	269.18	526	289.51	587	309.41		
283	205.95	344	227.57	405	248.76	466	269.51	527	289.84	588	309.73		
284	206.31	345	227.92	406	249.10	467	269.85	528	290.17	589	310.05		
285	206.67	346	228.27	407	249.45	468	270.19	529	290.50				
286	207.02	347	228.62	408	249.79	469	270.52			590	310.38		
287	207.38	348	228.97	409	250.13			530	290.83	591	310.70		
288	207.74	349	229.32			470	270.86	531	291.16	592	311.02		
289	208.10			410	250.48	471	271.20	532	291.49	593	311.34		
		350	229.67	411	250.82	472	271.53	533	291.81	594	311.66		
290	208.45	351	230.02	412	251.16	473	271.87	534	292.14	595	311.99		
291	208.81	352	230.37	413	251.50	474	272.20	535	292.47	596	312.31		
292	209.17	353	230.72	414	251.85	475	272.54	536	292.80	597	312.63		
293	209.52	354	231.07	415	252.19	476	272.88	537	293.13	598	312.95		
294	209.88	355	231.42	416	252.53	477	273.21	538	293.46	599	313.27		
295	210.24	356	231.77	417	252.87	478	273.55	539	293.79				
296	210.59	357	232.12	418	253.22	479	273.88			600	313.59		
297	210.95	358	232.47	419	253.56			540	294.11	601	313.91		
298	211.31	359	232.82			480	274.22	541	294.44	602	314.24		
299	211.66			420	253.90	481	274.55	542	294.77	603	314.56		
		360	233.17	421	254.24	482	274.89	543	295.10	604	314.88		
300	212.02	361	233.52	422	254.59	483	275.22	544	295.43	605	315.20		